

ROHS Compliant

DATE	2020/09/23
Revision	C

- Features :
- T-568A/B Dual wiring
 - RJ45 complies with FCC part 68 standard
 - 110/Krone dual IDC connector compatible
 - Provides termination for 22~26 AWG wire
 - Jack insertion life >750 mating cycles
 - IDC insertion life >250 mating cycles
 - Operating temperature : -40 °C~+60 °C
- Electrical :
- Contact resistance : 20m ohm
 - DC Current rating : 1.5Amps
 - DC resistance : Max.0.1 ohm
 - Insulation Resistance : 500m ohm
 - Dielectric withstanding voltage : 1000V

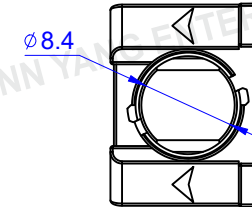
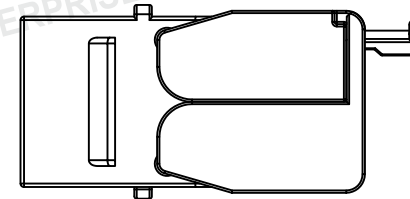
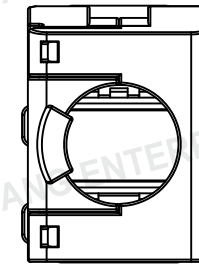
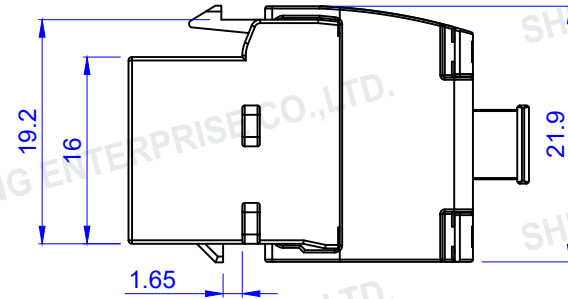
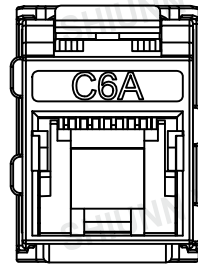
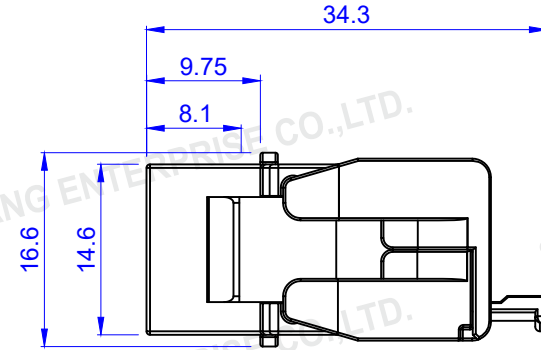

TOLERANCE

.XXX	0.10
.XX	0.25
.X	0.38

MATERIAL

CATEGORY CAT.5E CAT.6 CAT.6A CAT.3 OTHER _____

HOUSING ABS UL94V-0

CONTACT 0.35mm THICKNESS PHOSPHOR BRONZE GOLD PLATED OVER NICKEL

GOLD-PLATING 0.15um/6u inch 1.27um/50u inch

COLOR WHITE BLACK GREEN BLUE YELLOW RED ORANGE IVORY OTHER _____

TYPE OF PRODUCT UNSHIELD SHIELD : DIE CASTING

ITEM. SY504S-P6A

P/NO. Keystone Jack

CO. SY

S/N. SY504S-P6A

DR.

APPD. Sweet 2020/09/23

CHKD.



Shunn Yang Ent.Co.Ltd.
TEL: 29089890 <REP>
FAX: 29088679

FILE. SY504S-P6A

SCALE /

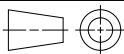

UNIT mm

SIZE A4

REV.	DESCRIPTION	ENG.	APPROVAL
------	-------------	------	----------