

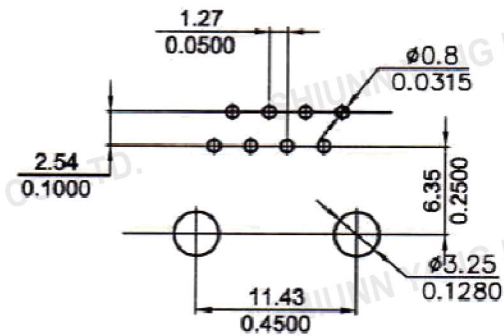

SY004S MINI - 8 □ □ □

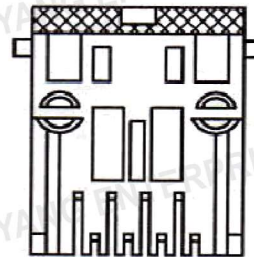
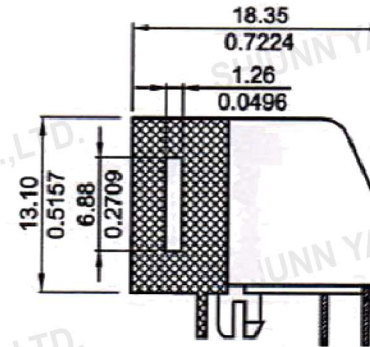
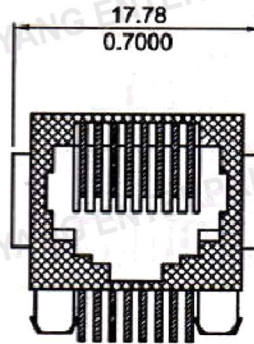
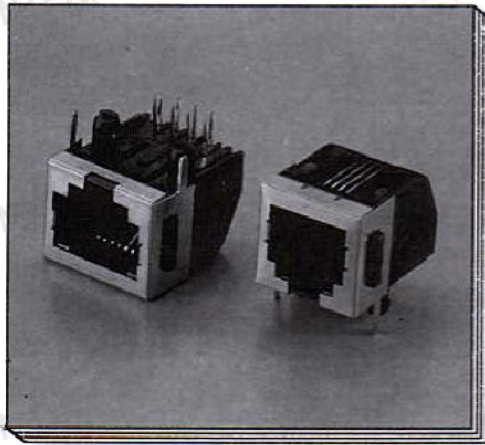

SHIELDING:0.25MM THICKNESS COPPER ALLOY WITH TIN PLATED

TECHNICAL DATA				TITLE	MODULAR PCB JACK	CO.	SY004S-MINI-8XXX	CLIE.	
HOUSING	STANDARD MATERIAL 15% GLASS FILLED PBT UL94V-0 STANDARD COLOR : GRAY, BLACK		COLD-PLATING	DR.		APPD.		CHKD.	
CONTACT	0.35 DIAMETER PHOSPHOR BRONZE GOLD PLATED OVER NICKEL			 Shiunn Yang Ent.Co.Ltd. TEL: 29089890 <REP> FAX: 29068849,29088679		SCALE /			
REV.	DESCRIPTION	ENG.	APPROVAL	UNIT mm		SIZE A4		SHEET	REV.